

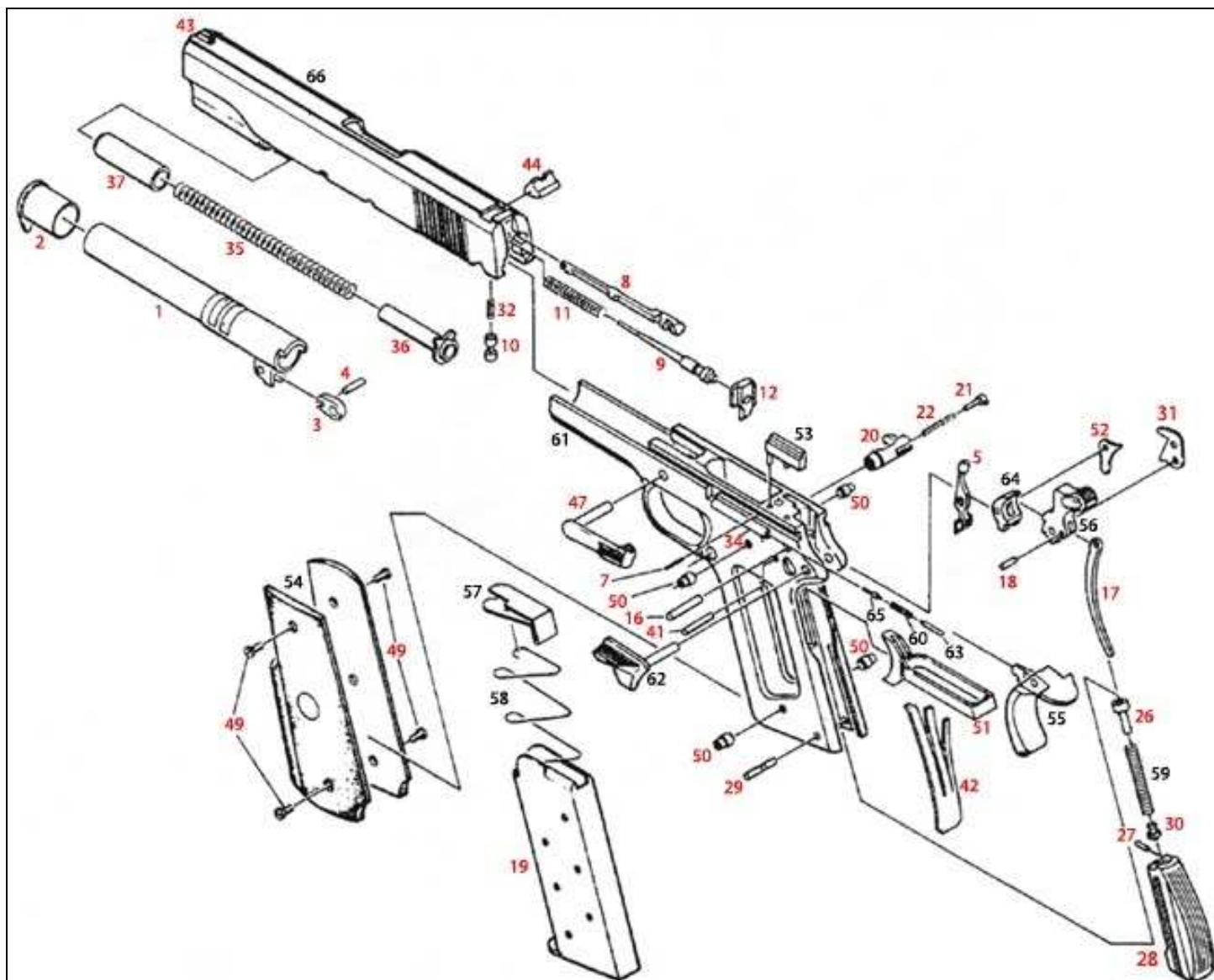









































RICAMBI COLT 1911 e cloni



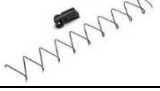



N° DESCRIZIONE	MARCA/TIPO	VARIANTE	FOTO	PREZZO
2 Barrel Bushing Blued	KIMBER			29,00
2 Barrel Bushing Stainless	SMITH & WESSON			27,00
3 Barrel Link	SMITH & WESSON			22,50
	STI	#3 (.278")		32,00
		#4 (.283")		32,00
		#5 (.288")		32,00
	WILSON COMBAT	#3 (.278")		18,00
4 Barrel Link Pin				4,00
5 Connector	EEMANN TECH			31,00
7 Ejector Pin				4,00
8 Extractor	39SHOOTER	Cal.9		27,00
	EEMANN TECH	Cal.9/38 SA/40 Stainless		34,00

		Cal.45		34,00	
9 Firing Pin Series 70/80	EEMANN TECH	Cal.9/38 SA/40		21,00	
	EEMANN TECH Extended	Cal.9/38 SA/40		23,00	
	SMITH & WESSON	Cal.45		15,00	
	STI	Cal.9/38 SA/40		32,50	
				5,00	
11 Firing Pin Spring	SMITH & WESSON			5,00	
	WOLFF Extra Power			8,00	
12 Firing Pin Stop	SMITH & WESSON			18,00	
16 Hammer Pin				5,00	
18 Hammer Strut Pin				4,90	
19 57 Magazine 58	ACT-MAG	Cal.9 10 colpi		20,00	
		Cal.45 8 colpi		21,00	
		Cal.45 8 colpi Nickel		24,00	
	COLT	Cal.9 Steyr		60,00	
		Defender/Officer's cal.45 6 colpi Stainless		65,00	
	E-LANDER	Caricatore realizzato in acciaio di alta qualità con resistenza alla corrosione certificata (96 h di esposizione all'acqua marina), testato ed utilizzato da forze speciali militari ed unità antiterrorismo. Elevatore anti-tilt per evitare inceppamenti, fondello con pad. Fabbricazione Israeliana	Cal.45 8 colpi		30,00 ESAURITO
	MEC-GAR		Cal.9 10 colpi Con pad		27,50
WILSON COMBAT		Cal.9 10 colpi Con pad		60,00	
19 Magazine Pad	ED BROWN Magazine Bumper Pads Conf. 6 pz.			30,00	
	KIMBER Extended Magazine Base Pads Conf. 3 pz.			14,00	
Magazine Catch	SMITH & WESSON			24,00	
20 Magazine Catch 2011	EEMANN TECH Stainless Maggiorato con pulsante eccentrico			81,00	
21 Magazine Catch Lock				6,00	
22 Magazine Catch Spring				5,00	
26 Mainspring Cap	EEMANN TECH			5,00	
28 Mainspring Housing	COLT	In plastica Curvo Silver		19,00	
29 Mainspring Housing Pin				ESAURITO	
30 Mainspring Housing Pin Retainer				ESAURITO	

32 Firing Pin Safety Spring	SMITH & WESSON			4,90
35 Recoil Spring	AMADINI CUSTOM Progressiva, conf. 2 pz.	Vari libbraggi		13,90
	EEMANN TECH Progressiva	Vari libbraggi		7,00
36 Recoil Spring Guide				
37 Recoil Spring Plug	EEMANN TECH	Brunito		15,00
41 Sear Pin				5,00
42 Sear Spring	SMITH & WESSON			12,50
44 Rear Sight	Spina per tacca di mira Elliason			5,00
47 Slide Stop	SMITH & WESSON			68,00
49 Grip Screw	Allen	Blued		5,00
		Stainless		5,00
	VZ GRIPS Radiation II Si adattano perfettamente a tutti i modelli di 1911. Prodotto di alta qualità Made in USA. Si montano con una chiave Torx 15. Adatte anche alle guance Slim	Blued		26,60
	VZ GRIPS Slex Si adattano perfettamente a tutti i modelli di 1911. Prodotto di alta qualità Made in USA. Si montano con una chiave esagonale da 3/32. Adatte anche alle guance Slim	Blued		12,00
		Stainless		12,00
50 Grip Screw Bushing		Blued		4,90
		Stainless		4,90
53 Ejector	39Shooter	Cal.9 mm		14,00
		Cal.45 Blued		18,00
		Cal.45 Stainless		18,00
54 Grips	FAB DEFENSE Guance in plastica con minigonna integrata			22,00
	HOGUE Extreme Series Guance in alluminio, lisce, colore nero, usate			40,00
	HOGUE Rubber Grips Guance in gomma			26,00
	HOGUE Rubber Grip Guance in gomma con sagomatura per le dita, usate come nuove			20,00

	KIMBER Eclipse Guance in legno laminato grigio/nero			75,00
	SMITH & WESSON Checkered Rubber Guance in gomma ziggrinate con logo S&W			47,00
	TONI SYSTEM Vibram Guance in alluminio con profilo ultrasottile e grip ricavato grazie a dei solchi molto marcati	Nero		83,00
	VZ GRIPS Double Diamond Indian Rosewood Guance in legno con il classico grip Double Diamond rivisto da VZ Grip per ottimizzare al meglio lo stile. Realizzate con macchine a controllo numerico per dare la forma più grippante a diamante ma rifinite a mano per renderle perfette nel calzare le 1911			98,00
	VZ GRIPS Operator II Carbon Fiber Guance in fibra di carbonio che uniscono un aggressivo grip a righe trasversali nella parte posteriore ad un ultra-aggressivo design a "golf ball" nella parte anteriore	White		133,00
	VZ GRIPS Operator II G10 Guance in G10 che uniscono un aggressivo grip a righe trasversali nella parte posteriore ad un ultra-aggressivo design a "golf ball" nella parte anteriore	Dirty Olive Slim		77,50
	VZ GRIPS Stipple Carbon Fiber Le guance VZ Stipple hanno un disegno studiato e realizzato ispirandosi ai materiali naturali più grippanti. Realizzate in fibra di carbonio, sono lavorate con macchine a controllo numerico per dare la forma più grippante e rifinite a mano per calzare perfettamente sulle 1911	Black		133,00
56	DOUG KOENIG Low Mass Cane ultra-leggero in acciaio. Il peso è estremamente contenuto per un tempo di scatto molto più rapido rispetto ai cani standard, consentendo inoltre l'uso di molla cane più di minor libbraggio per uno scatto più leggero. Pesa solo 9 g			134,00
	SMITH & WESSON			79,00
57 Magazine Spring 58 Magazine Follower	WILSON COMBAT Spring/Follower Kit Kit composto da molla ed elevatore	Cal.38SA/10mm		14,00
58 Magazine Spring				6,00
59 Mainspring	GHOST INTERNATIONAL	23 Lb		4,00
	EEMANN TECH	Vari libbraggi		5,00
	SMITH & WESSON	23 Lb		5,00
	TONI SYSTEM	15, 16, 17 Lb		6,00
60 Plunger Spring	SMITH & WESSON			4,90
62 Safety Lock	WILSON COMBAT Ambidextrous Thumb Safety High Ride Stainless			99,00
63 Safety Lock Plunger				4,90
64 Sear	ED BROWN Perfection Sear Sear pre-lavorato per minimizzare il lavoro di aggiustaggio			54,00

SMITH & WESSON		39,00
STI S7 DVC		65,00
65 Slide Stop Plunger		4,90
TAC VECTOR Base per il montaggio di micro red dot, applicabile a tutti i modelli 1911 e cloni con mira fissa, compatibile con micro red dot Vector, Burris, Vortex e Docter		32,00