

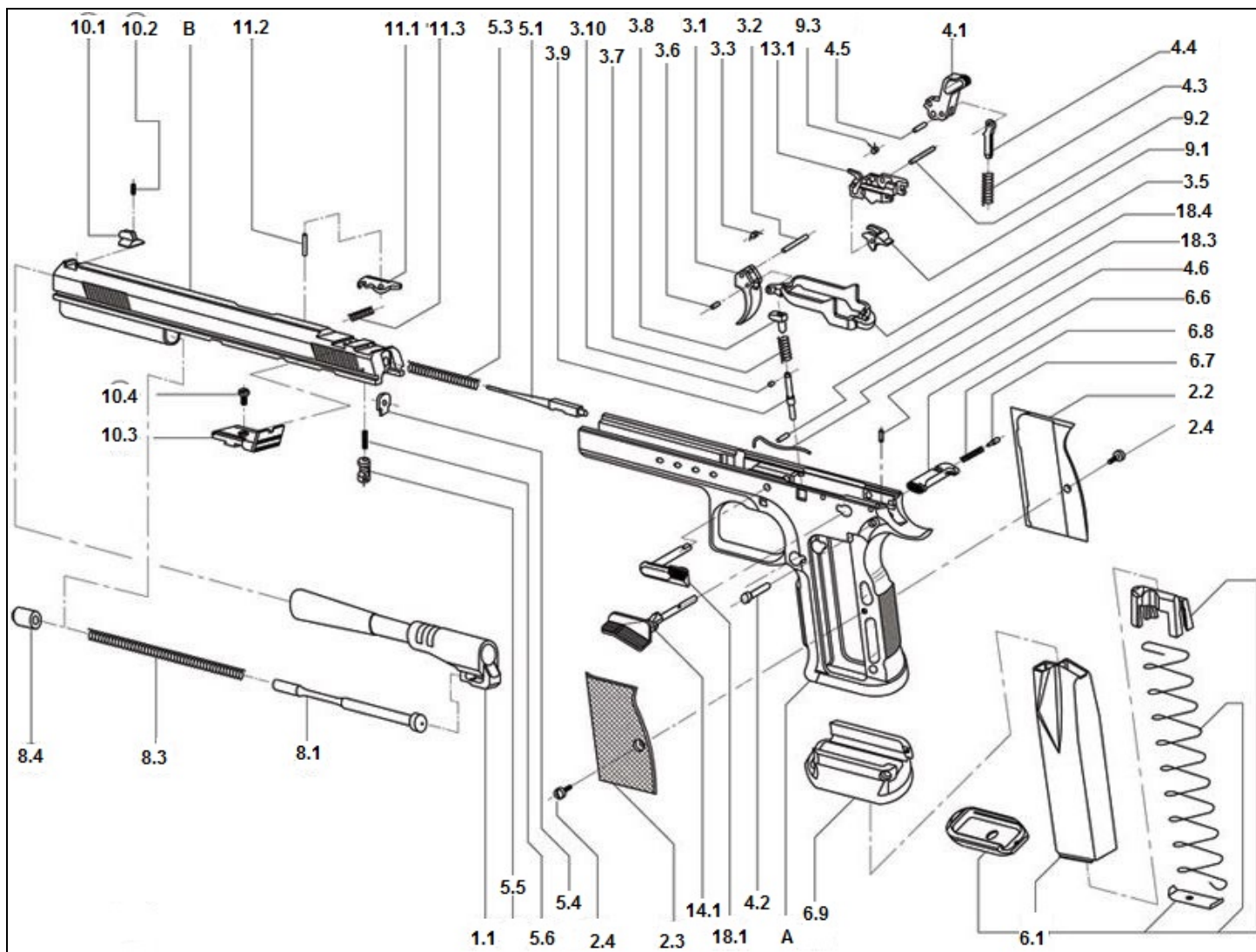





















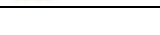







RICAMBI TANFOGLIO



N°	DESCRIZIONE	VARIANTE	FOTO	PREZZO
	TANFOGLIO Guance in alluminio zigrinate Per modelli con ponticello tondo	Rosso		85,00
	TANFOGLIO Guance in alluminio zigrinate Per modelli con ponticello squadrato	Nero		85,00
		Silver		
2.(2+3)	TANFOGLIO Guance in alluminio lisce Per modelli con ponticello squadrato	Silver		85,00
	TANFOGLIO Guance in alluminio lisce Per modelli con ponticello squadrato con minigonna	Silver		85,00
	TANFOGLIO XTREME Guance in alluminio zigrinate con loghi Xtreme Per modelli con ponticello squadrato	Nero		85,00
		Silver		90,00

	TANFOGLIO XTREME Guance in alluminio zigrinate con loghi Xtreme Per modelli con ponticello squadrato con minigonna	Nero		80,00
	TONI SYSTEM Vibram Guance in alluminio Per modelli con ponticello squadrato	Blu		83,00
2.4	Vite guancia Standard per guance in legno			3,00
	Vite guancia Standard per guance in alluminio			4,00
	Vite guancia Torx per guance in alluminio			5,00
	Vite guancia Xtreme per guance in alluminio			5,00
3.1	Grilletto Standard per doppia azione, usato			10,00
	Grilletto Stock per doppia azione			49,00
3.3	Molla grilletto per doppia azione			3,00
3.(7->10)	Gruppo molla leva collegamento			11,00
3.5	Leva collegamento per fusto Small			63,00
4.1	Cane Standard per doppia azione, brunito			49,00
	Cane Delta per singola azione, cromato			49,00
4.1	Dente cane Xtreme			17,00
4.2	Perno cane			3,00
4.3	Molla cane Standard			3,00
	Molla cane Stock			3,00
	Molla cane Xtreme Light			8,00
	Molla cane TONI SYSTEM			6,00
4.6	Spina fermo perno cane			3,00
5.1	Percussore Standard per fusto Small, versione R			18,00
	Percussore Custom per fusto Small			25,00
	Percussore Custom per fusto Large			25,00
	Percussore Xtreme per fusto Small			33,00
5.3	Molla percussore			3,00
	Molla percussore Xtreme Medium			8,00
5.4	Fermo percussore			8,00
5.5	Molla sicura percussore			3,00
5.6	Sicura percussore			16,00
6.1	Caricatore 9 mm cromato con pad alluminio Xtreme			40,00

	Caricatore Force 22			25,00
	Caricatore Force 9 mm			35,00
	Caricatore P25			35,00
6.1	Fondello caricatore con pad in gomma per fusto Small			15,00
	Fondello caricatore in alluminio per fusto Small			33,00
	Fondello caricatore in alluminio per fusto Small con minigonna			33,00
6.6	Sgancio caricatore Standard brunito			17,00
	Sgancio caricatore Custom brunito			38,00
	Sgancio caricatore Custom cromato			38,00
6.7	Guidamolla sgancio percussore			3,00
6.8	Molla sgancio percussore			3,00
8.1	Guidamolla recupero Sport Per modelli con canna 121 mm			22,00
	Guidamolla recupero GBO in Tungsteno Per modelli con canna 121 mm			95,00
	Molla recupero AMADINI CUSTOM progressiva, disponibile in diversi libbraggi	1 pz.		7,00
		Conf. 2 pz.		13,90
	Molla recupero TANFOGLIO per Force Compact			7,00
	Molla recupero TANFOGLIO per Force 22			
8.3	Molla recupero TANFOGLIO per modelli con canna 113 mm	10 Lb		
		11 Lb		7,00
		11 Lb		
	Molla recupero TANFOGLIO per modelli con canna 121 mm	12 Lb		
	Molla recupero TONI SYSTEM			9,00
	Leva scatto per singola azione			25,00
9.1	Leva scatto LSPA			18,00
	Leva scatto LSPA completa			21,00
9.2	Perno leva scatto			3,00
9.3	Molla leva scatto			3,00
10.(1+2)	Mirino Custom	3x5,5 mm		23,00
	Mirino a innesto trasversale con fibra ottica	3,5x5,6 mm		35,00
10.(3+4)	Tacca di mira Supersight			70,00
11.1	Estrattore 9 mm			16,00
11.2	Perno estrattore			3,00
11.3	Molla estrattore			4,00
13.1	Blocco espulsore per fusto Small			63,00

	Sicura maggiorata ambidestra PR017	Brunita		77,00
		Cromata		
14.1	Sicura Custom ambidestra PR018	Brunita		94,00
		Cromata		
	Grano, disponibile nelle varie misure			3,00
	Spina elastica, disponibile nelle varie misure			3,00
	TONI SYSTEM IDPA Minigonna per IDPA, larghezza 39,5 mm, compatibile con i pad Toni System	Blu		98,00
	EEMANN TECH Springs Kit Kit comprendente molle di ricambio, di caratteristiche pari a quelle originali Il kit comprende: • Recoil Spring 15 Lb • Hammer Spring 16 Lb • Trigger Spring • Firing Pin Spring • Sear Spring • Magazine Catch Spring • Firing Pin Safety Spring for Tanfoglio • Extractor Spring			22,00
	EEMANN TECH Upgrade Kit Kit comprendente le parti necessarie per migliorare le prestazioni della tua Tanfoglio, da out-of-the-box a Competition. Le molle Eemann Tech Competition springs riducono peso di scatto e aumentano la velocità di funzionamento dell'arma. Il disconnettore Eemann Tech Competition Disconnecter assicura un reset estremamente corto Il kit comprende: • Eemann Tech Competition Disconnecter • Eemann Tech Disconnecter Pin • Eemann Tech Recoil Spring 10 Lb • Eemann Tech Hammer Spring 13 Lb • Eemann Tech Competition Trigger Spring • Eemann Tech Competition Buffer 5 pz.			95,00